



Panasonic®

Operating Instructions CD Stereo System

Model No. **SC-PM23**



As an ENERGY STAR® Partner*, Panasonic has determined that this product meets the ENERGY STAR® guidelines for energy efficiency.

*For Canada only: The word "Participant" is used in place of the word "Partner".



Table of contents

IMPORTANT SAFETY	
INSTRUCTIONS	3
Listening caution	3
Getting started	4
Placement of speakers	5
Overview of controls	6
Discs	7
Cassette tape	9
Radio	10
Timer	11
Sound adjustment	13
External unit	13
Troubleshooting guide	14
Specifications	15
Maintenance	15
Limited Warranty	
(ONLY FOR U.S.A.)	16
Limited Warranty	
(ONLY FOR CANADA)	17
Product Service	17

Español

Preparativos iniciales	18
Colocación de los altavoces	18
Controles	19
Discos	20
Cintas de casete	21
Radio	22
Temporizador	23

SUPPLIED ACCESSORIES

Please check and identify the supplied accessories. Use numbers indicated in parentheses when asking for replacement parts. (As of December 2005)
In the U.S.A. to order accessories, refer to "Accessory Purchases" on page 16.

1 x Remote control

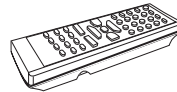

(N2QAYB000005)

1 x AM loop antenna

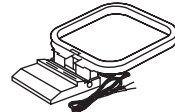

(N1DAAAA00001)

1 x AC power supply cord

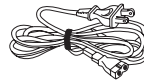

(K2CB2CB00018)

1 x FM indoor antenna

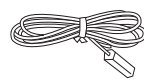

(RSA0007-L)

2 x Remote control batteries



Before connecting, operating or adjusting this product, please read the instructions completely. Please keep this manual for future reference.

Operations in these instructions are described using remote control, but you can do the operations with the main unit if the controls are the same.

Your unit may not look exactly as illustrated.

La guía rápida en español se encuentra en la página 18 - 23.

Dear customer

Thank you for purchasing this product.
For optimum performance and safety, please read these instructions carefully.

These operating instructions are applicable to the following system.

System	SC-PM23
Main unit	SA-PM23
Speakers	SB-PM23

The model number and serial number of this product can be found on either the back or the bottom of the unit. Please note them in the space provided below and keep for future reference.

MODEL NUMBER _____
SERIAL NUMBER _____

User memo:

DATE OF PURCHASE _____
DEALER NAME _____
DEALER ADDRESS _____

TELEPHONE NUMBER _____

WARNING:

TO REDUCE THE RISK OF FIRE, ELECTRIC SHOCK OR PRODUCT DAMAGE, DO NOT EXPOSE THIS APPARATUS TO RAIN, MOISTURE, DRIPPING OR SPLASHING AND THAT NO OBJECTS FILLED WITH LIQUIDS, SUCH AS VASES, SHALL BE PLACED ON THE APPARATUS.

CAUTION!

THIS PRODUCT UTILIZES A LASER. USE OF CONTROLS OR ADJUSTMENTS OR PERFORMANCE OF PROCEDURES OTHER THAN THOSE SPECIFIED HEREIN MAY RESULT IN HAZARDOUS RADIATION EXPOSURE. DO NOT OPEN COVERS AND DO NOT REPAIR YOURSELF. REFER SERVICING TO QUALIFIED PERSONNEL.

CAUTION!

DO NOT INSTALL OR PLACE THIS UNIT IN A BOOKCASE, BUILT-IN CABINET OR IN ANOTHER CONFINED SPACE. ENSURE THE UNIT IS WELL VENTILATED. TO PREVENT RISK OF ELECTRIC SHOCK OR FIRE HAZARD DUE TO OVERHEATING, ENSURE THAT CURTAINS AND ANY OTHER MATERIALS DO NOT OBSTRUCT THE VENTILATION VENTS.

The socket outlet shall be installed near the equipment and easily accessible or the mains plug or an appliance coupler shall remain readily operable.



CAUTION
RISK OF ELECTRIC SHOCK
DO NOT OPEN



CAUTION: TO REDUCE THE RISK OF ELECTRIC SHOCK, DO NOT REMOVE SCREWS. NO USER-SERVICEABLE PARTS INSIDE. REFER SERVICING TO QUALIFIED SERVICE PERSONNEL.

 The lightning flash with arrowhead symbol, within an equilateral triangle, is intended to alert the user to the presence of uninsulated "dangerous voltage" within the product's enclosure that may be of sufficient magnitude to constitute a risk of electric shock to persons.

 The exclamation point within an equilateral triangle is intended to alert the user to the presence of important operating and maintenance (servicing) instructions in the literature accompanying the appliance.

THE FOLLOWING APPLIES ONLY IN THE U.S.A.

FCC Note:

This equipment has been tested and found to comply with the limits for a Class B digital device, pursuant to Part 15 of the FCC Rules.

These limits are designed to provide reasonable protection against harmful interference in a residential installation. This equipment generates, uses and can radiate radio frequency energy and, if not installed and used in accordance with the instructions, may cause harmful interference to radio communications. However, there is no guarantee that interference will not occur in a particular installation. If this equipment does cause harmful interference to radio or television reception, which can be determined by turning the equipment off and on, the user is encouraged to try to correct the interference by one or more of the following measures:

- Reorient or relocate the receiving antenna.
- Increase the separation between the equipment and receiver.
- Connect the equipment into an outlet on a circuit different from that to which the receiver is connected.
- Consult the dealer or an experienced radio/TV technician for help.

Any unauthorized changes or modifications to this equipment would void the user's authority to operate this device.

This device complies with Part 15 of the FCC Rules. Operation is subject to the following two conditions: (1) This device may not cause harmful interference, and (2) this device must accept any interference received, including interference that may cause undesired operation.

Responsible Party:
Panasonic Corporation of North America
One Panasonic Way
Secaucus, NJ 07094
Telephone No.: 1-800-211-7262

IMPORTANT SAFETY INSTRUCTIONS

Read these operating instructions carefully before using the unit. Follow the safety instructions on the unit and the applicable safety instructions listed below. Keep these operating instructions handy for future reference.

- 1) Read these instructions.
- 2) Keep these instructions.
- 3) Heed all warnings.
- 4) Follow all instructions.
- 5) Do not use this apparatus near water.
- 6) Clean only with dry cloth.
- 7) Do not block any ventilation openings. Install in accordance with the manufacturer's instructions.
- 8) Do not install near any heat sources such as radiators, heat registers, stoves, or other apparatus (including amplifiers) that produce heat.
- 9) Do not defeat the safety purpose of the polarized or grounding-type plug. A polarized plug has two blades with one wider than the other. A grounding-type plug has two blades and a third grounding prong. The wide blade or the third prong are provided for your safety. If the provided plug does not fit into your outlet, consult an electrician for replacement of the obsolete outlet.
- 10) Protect the power cord from being walked on or pinched particularly at plugs, convenience receptacles, and the point where they exit from the apparatus.
- 11) Only use attachments/accessories specified by the manufacturer.
- 12) Use only with the cart, stand, tripod, bracket, or table specified by the manufacturer, or sold with the apparatus. When a cart is used, use caution when moving the cart/apparatus combination to avoid injury from tip-over. 
- 13) Unplug this apparatus during lightning storms or when unused for long periods of time.
- 14) Refer all servicing to qualified service personnel. Servicing is required when the apparatus has been damaged in any way, such as power-supply cord or plug is damaged, liquid has been spilled or objects have fallen into the apparatus, the apparatus has been exposed to rain or moisture, does not operate normally, or has been dropped.

Listening caution



Selecting fine audio equipment such as the unit you've just purchased is only the start of your musical enjoyment. Now it's time to consider how you can maximize the fun and excitement your equipment offers. This manufacturer and the Electronic Industries Association's Consumer Electronics Group want you to get the most out of your equipment by playing it at a safe level. One that lets the sound come through loud and clear without annoying blaring or distortion—and, most importantly, without affecting your sensitive hearing.

We recommend that you avoid prolonged exposure to excessive noise.

Sound can be deceiving. Over time your hearing "comfort level" adapts to higher volumes of sound. So what sounds "normal" can actually be loud and harmful to your hearing. Guard against this by setting your equipment at a safe level BEFORE your hearing adapts.

To establish a safe level:

- Start your volume control at a low setting.
- Slowly increase the sound until you can hear it comfortably and clearly, and without distortion.

Once you have established a comfortable sound level:

- Set the dial and leave it there.

Taking a minute to do this now will help to prevent hearing damage or loss in the future. After all, we want you listening for a lifetime.

-If you see this symbol-

Information on Disposal in other Countries outside the European Union



This symbol is only valid in the European Union. If you wish to discard this product, please contact your local authorities or dealer and ask for the correct method of disposal.

Except for U.S.A.

CAUTION	CLASS 1M INVISIBLE LASER RADIATION WHEN OPEN AND INTERLOCKS DEFEATED. DO NOT VIEW DIRECTLY WITH OPTICAL INSTRUMENTS. IEC60825-1 +A2/Class 1M.
VARNING	KLASS 1M OSYNLIG LASERSTRÅLNING NÄR DENNA DEL ÄR ÖPPNAD OCH SPÄRREN ÄR URKOPPLAD. BETRÄKTA EJ STRÅLEN DIREKT GENOM OPTISKT INSTRUMENT.
FORSIGTIG	USYNLIG LASERSTRÅLNING KLASSE 1M. NÄR LÅGET ER ÅBENT OG SIKKERHEDSÅBRYDERE ER LUDE AF FUNKTION. UNDGÅ AT SE LIGE PÅ MED OPTISKE INSTRUMENTER.
VARO	AVATTRESSA JA SUOJALUKITUS OHTETTRESSA OLET ALTIMA LUOKAN 1M NÄKYMÄTÖNTÄ LASERSÄTELYÄ. ÄLÄ KATSO OPTISELLÄ LAITTEELLA SUORAAN SÄTEESEEN.
VORSICHT	UNSICHTBARE LASERSTRÄHLUNG KLASSE 1M. WENN ABDECKUNG GEÖFFNET UND SICHERHEITSVERRIEGELUNGEN ÜBERBRÜCKT NICHT DIREKT MIT OPTISCHEN INSTRUMENTEN BETRACHTEN.
ATTENTION	RAYONNEMENT LASER INVISIBLE. CLASSE 1M. EN CAS D'OUVERTURE ET LORSQUE LA SÉCURITÉ EST NEUTRALISÉE. NE PAS REGARDER DIRECTEMENT À L'AIDE D'INSTRUMENTS D'OPTIQUE. ROLVS0033

Inside of product

Getting started

Step 1 - Making the connections

Connect the AC power supply cord only after all other connections have been made.

1 Connect the AM loop antenna.

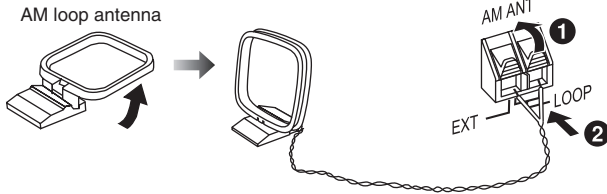

Stand the antenna up on its base. Keep the loose antenna cord away from other wires and cords.

2 Connect the FM indoor antenna.

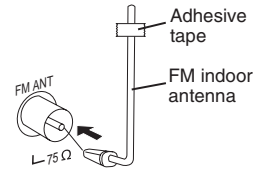

Tape the antenna to a wall or column, in a position with least amount of interference.

3 Connect the speaker cords.

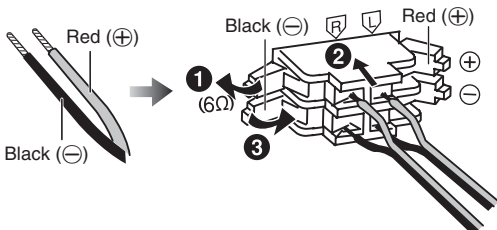

Incorrect connection can damage the unit.

4 Connect the AC power supply cord.

The included AC power supply cord is for use with this unit only. Do not use it with other equipment.

Optional antenna connections

FM outdoor antenna

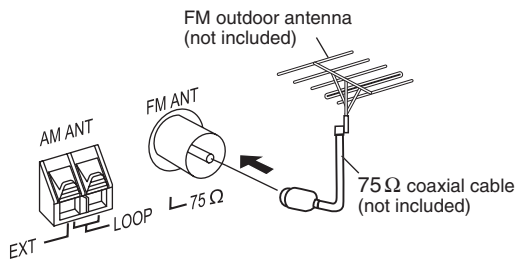

AM outdoor antenna

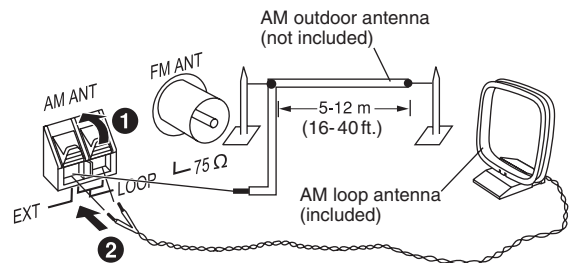

- Never use an outdoor antenna during a lightning storm.
- You can connect the FM outdoor antenna for better reception. Please consult your dealer for installation.
- Disconnect the FM indoor antenna if an FM outdoor antenna is installed.
- Connect the AM outdoor antenna without removing the AM loop antenna. Run 5 to 12 m (16 to 40 feet) of vinyl-covered wire horizontally along a window or other convenient location.

Step 2 - Inserting batteries into the remote control

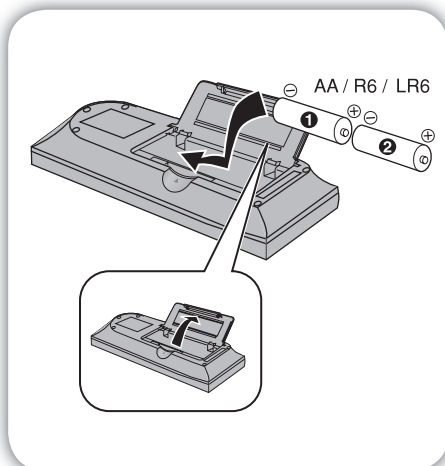

■ Batteries

- Insert so the poles (+ and -) match those in the remote control.
- Remove if the remote control is not going to be used for a long period of time. Store in a cool, dark place.
- Do not use rechargeable type batteries.
- Mishandling of batteries in the remote control can cause electrolyte leakage, which may cause a fire.

Do not:

- mix old and new batteries;
- use different types of batteries at the same time;
- heat or expose to flame;
- take apart or short-circuit;
- attempt to recharge alkaline or manganese batteries;
- use batteries if their covering has been peeled off.

■ Use

Aim at the remote control sensor, avoiding obstacles, at a maximum range of 7 m (23 feet) directly in front of the unit.
Refer to page 6 for remote control signal sensor position.

Step 3 - DEMO function



When the unit is first plugged in, a demonstration of its functions may be shown on the display.

If the demo setting is off, you can show a demonstration by selecting "DEMO ON".

Press and hold [■, -DEMO].

The display changes each time the button is held down.

→ DEMO OFF → DEMO ON

While in standby mode, select "DEMO OFF" to reduce power consumption.

Placement of speakers



Speakers are designed identically so that no left or right channel orientation is necessary.

Use only the supplied speakers.

The combination of the main unit and speakers provide the best sound. Using other speakers can damage the unit and sound quality will be negatively affected.

Note

- Keep your speakers at least 10 mm ($13/32$ ") away from the system for proper ventilation.
- These speakers do not have magnetic shielding. Do not place them near televisions, personal computers or other devices easily influenced by magnetism.
- You cannot take the front net off the speakers.



Caution

- Use the speakers only with the recommended system. Failure to do so can damage the amplifier and speakers, and can cause fire. Consult a qualified service person if damage occurs or if a sudden change in performance is apparent.
- Do not attach these speakers to walls or ceilings.

Overview of controls

Main unit

Refer to the numbers in parentheses for page reference.

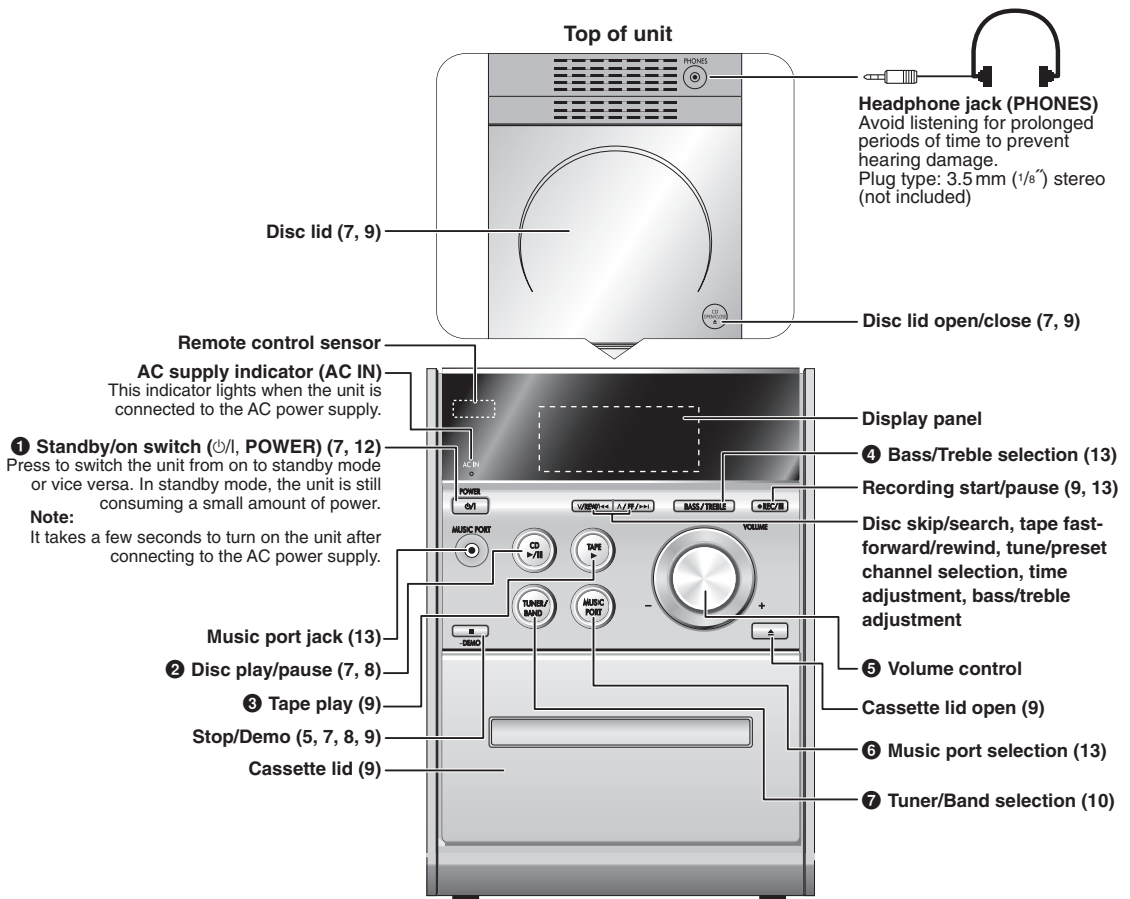

Remote control

Buttons such as **1** function the same as the controls on the main unit.

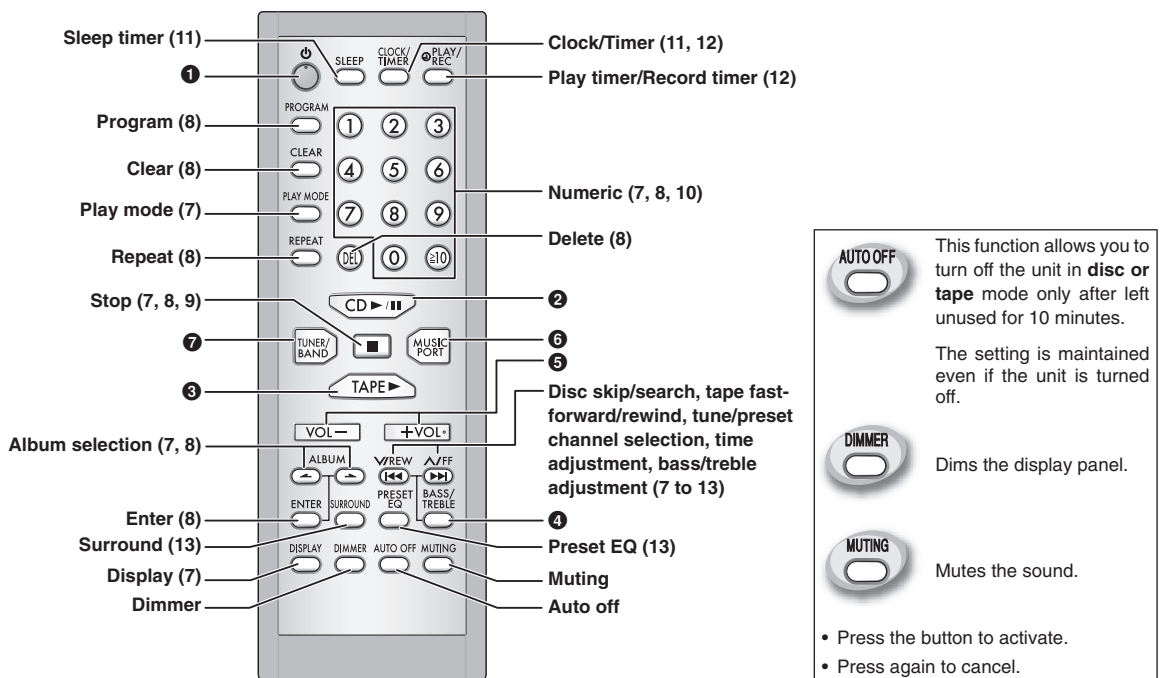

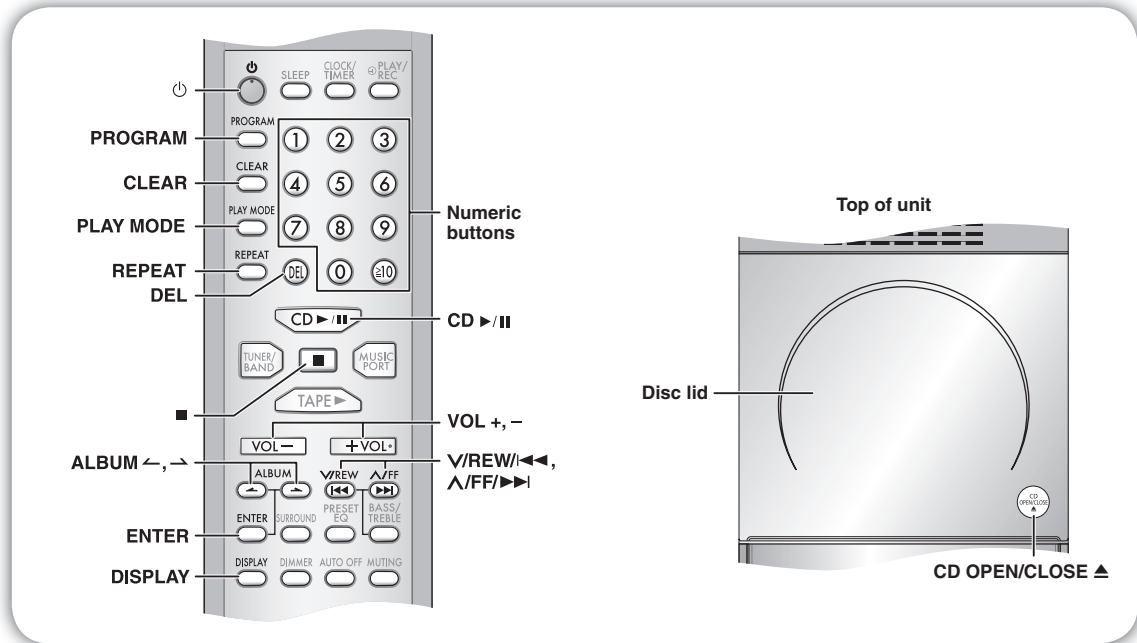

Basic play

CD MP3 WMA

- 1 Press [POWER] to turn the unit on.
- 2 Push [CD OPEN/CLOSE] to open the disc lid and then insert the disc. Close the lid.

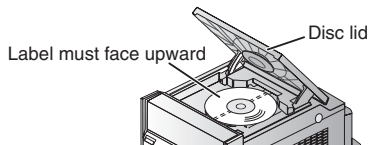

- 3 Press [CD] to start play.
- 4 Adjust the volume.

To	Action
stop the disc	Press [STOP].
pause play	Press [CD]. Press again to resume play.
skip tracks	Press [V/REW/FF] or [V/FF/FF].
search through tracks	Press and hold [V/REW/FF] or [V/FF/FF] during play or pause.
skip album	Press [ALBUM] in the play mode. Press [ALBUM] once and then the numeric buttons in the stop mode.

Play Mode function

CD MP3 WMA

- 1 Press [CD].
- 2 Press [PLAY MODE] to select the desired mode.

Mode	To play
1-TRACK 1TR	one selected track on the disc. Press the numeric buttons to select the track.
1-ALBUM 1ALBUM MP3 WMA	one selected album on the disc. Press [ALBUM] to select the album.
RANDOM RND	a disc randomly.
1-ALBUM RANDOM 1ALBUM RND MP3 WMA	all tracks in one selected album randomly. Press [ALBUM] to select the album.

Note

- During RANDOM or 1-ALBUM RANDOM play, you cannot skip to tracks that have been played.
- During RANDOM play, you can search backward or forward only within the current track.

Display function

This function allows you to display the information of the current track.

Press [DISPLAY] repeatedly during play or pause mode.

CD

→ Elapsed play time → Remaining play time →

MP3 WMA

→ Elapsed time → Album name → Track name
Tag (Artist) ← Tag (Track) ← Tag (Album) ←

Note

- Maximum number of displayable characters: approximately 30
- This unit supports ver. 1.0 & 1.1 ID3 tags. Text data that is not supported will not be displayed.
- ID3 is a tag embedded in MP3 tracks to provide information about the track.

Advanced play

Direct access play

This function allows you to start play from a specific track.

CD

Press the numeric buttons to select and play your desired track.

MP3 WMA

- 1 Press [ALBUM ← or →] to select the album.
- 2 Press [^/FF/▶▶] once and then the numeric buttons to select and play your desired track.

For two-digit track, press [≥10] once, and then the two digits. For three-digit track, press [≥10] twice, and then the three digits.

Note

This function does not work during any random/program mode.

Repeat play

You can repeat program play or other selected play mode.

CD MP3 WMA

Press [REPEAT] before or during play. "REPEAT ON" and "⊞" are displayed.

To cancel

Press [REPEAT] again.

"REPEAT OFF" is displayed and "⊞" is cleared.

Program play

This function allows you to program up to 24 tracks.

CD

- 1 Press [CD ▶/II] and then [■].
- 2 Press [PROGRAM].
- 3 Press the numeric buttons to select your desired track. Repeat this step to program other tracks. Example:

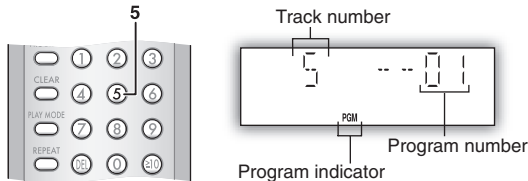

- 4 Press [CD ▶/II] to start play.

Note

- This unit can play MP3 or WMA files and CD-DA format audio CD-R/RWs that have been finalized.
- It may not be able to play some CD-R/RWs, depending on the condition of the recording.
- Do not use irregularly shaped discs.
- Do not use discs with labels and stickers that are coming off or with adhesive exuding from under labels and stickers.
- Do not attach extra labels or stickers on the disc.
- Do not write anything on the disc.

CD

- This unit can access up to 99 tracks.
- Choose a CD with this mark:



Using DualDiscs

The "CD" sides of DualDiscs do not meet the CD-DA standard so it may not be possible to play them on this unit.

MP3 WMA

- 1 Press [CD ▶/II] and then [■].
- 2 Press [PROGRAM].
- 3 Press [ALBUM ← or →] to select your desired album.
- 4 Press [^/FF/▶▶] once and then the numeric buttons to select your desired track.

Example:

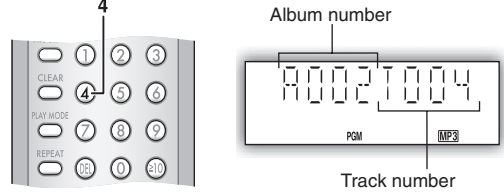

- 5 Press [ENTER] to store the program. Repeat steps 3 to 5 to program other tracks.
- 6 Press [CD ▶/II] to start play.

To	Action
cancel program mode	Press [PROGRAM] in the stop mode.
replay the program	Press [PROGRAM] then [CD ▶/II].
check program contents	Press [√/REW/◀◀] or [^/FF/▶▶] when "PGM" is displayed in the stop mode. To check while programming, press [PROGRAM] twice after "PGM" appears, then press [√/REW/◀◀] or [^/FF/▶▶].
add to the program	CD Repeat step 3 in the stop mode. MP3 WMA Repeat steps 3 to 5 in the stop mode.
clear the last track	Press [DEL] in the stop mode.
clear all programmed tracks	Press [CLEAR] in the stop mode. "CLR ALL" is displayed.

Note

- When you try to program more than 24 tracks, "PGM FULL" appears.
- The program memory is cleared when you open the disc lid.

CD

During program play, you can search backward or forward only within the current track.

MP3 WMA

- Files are treated as tracks and folders are treated as albums.
- This unit can access up to 999 tracks, 255 albums and 20 sessions.
- Disc must conform to ISO9660 level 1 or 2 (except for extended formats).
- To play in a certain order, prefix the folder and file names with the 3-digit numbers in the order you want to play them.

MPEG Layer-3 audio decoding technology licensed from Fraunhofer IIS and Thomson multimedia.

Windows Media, and the Windows logo are trademarks, or registered trademarks of Microsoft Corporation in the United States and/or other countries.

WMA is a compression format developed by Microsoft Corporation. It achieves the same sound quality as MP3 with a file size that is smaller than that of MP3.



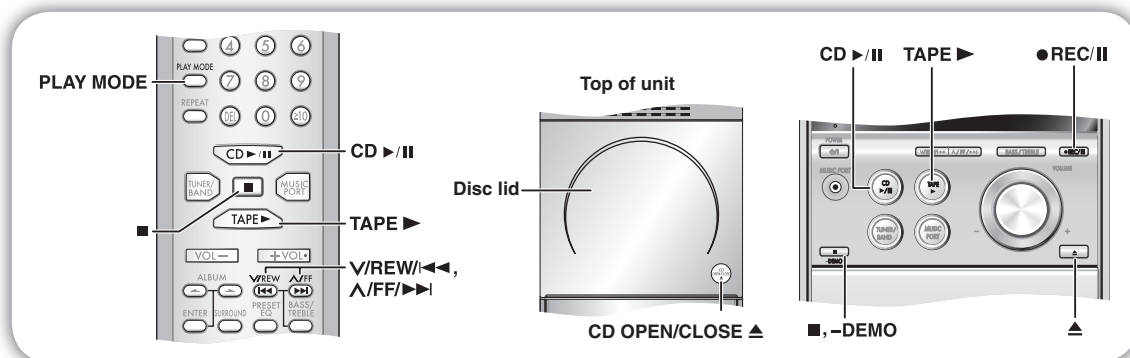

Basic play

- 1 Press [▲] and insert the cassette.

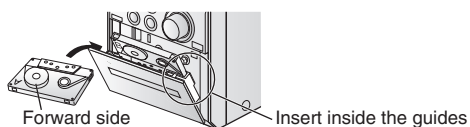

- 2 Close the lid by hand.
- 3 Press [TAPE >] to start play.
To play the other side of the cassette, turn the cassette over.

To	Action
stop tape playback	Press [■].
start one-touch play	Press [TAPE >] when the unit is OFF with the cassette loaded.
fast-forward and rewind	Press [V/REW/◀◀] or [^/FF/▶▶] in the stop mode.

Note

- Tapes exceeding 100 minutes are thin and can break or get caught in the mechanism.
- Endless tapes can get caught up in the deck's moving parts if used incorrectly.

TPS (Tape Program Sensor)

This function enables you to search the beginning of a track, up to a maximum of 9.

Press [V/REW/◀◀] or [^/FF/▶▶] during play.

Play resumes from the track found.

Note

- TPS may not function properly:
- with short silent parts
 - when noise occurs between tunes
 - if silent parts are found within tunes

Recording

Use normal position tapes.

High position and metal position tapes can be used, but this unit will not be able to record or erase them correctly.

Preparation

Wind the leader tape so that recording can begin immediately.

Recording the radio

- 1 Insert the cassette to be recorded.
- 2 Tune to the required station (refer to page 10).
- 3 Press [● REC/||] to start recording.

Recording discs

- 1 Insert the cassette to be recorded.
- 2 Push [CD OPEN/CLOSE ▲] to insert the disc and close the lid.
- 3 Press [CD >||] and then [■, -DEMO].
- 4 Press [PLAY MODE] to select your desired mode (refer to page 7).
- 5 Press [● REC/||] to start recording.

Recording programmed tracks

- 1 Insert the cassette to be recorded.
- 2 Program the tracks you want (refer to page 8).
- 3 Press [● REC/||] to start recording.

Other basic operations

To	Action
erase a recorded sound	1) Insert the cassette to be recorded. 2) Press [TAPE >] and then [■, -DEMO]. 3) Press [● REC/].
stop recording	Press [■].
stop recording temporarily	1) Press [● REC/]. 2) Press again to resume recording.
record on the other side of the tape	Turn the cassette over and press [● REC/].

Erase prevention

The illustration shows how to remove the tabs to prevent recording. To record on the tape again, cover as shown.

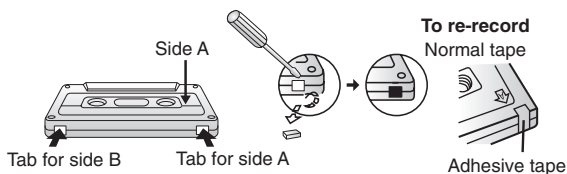

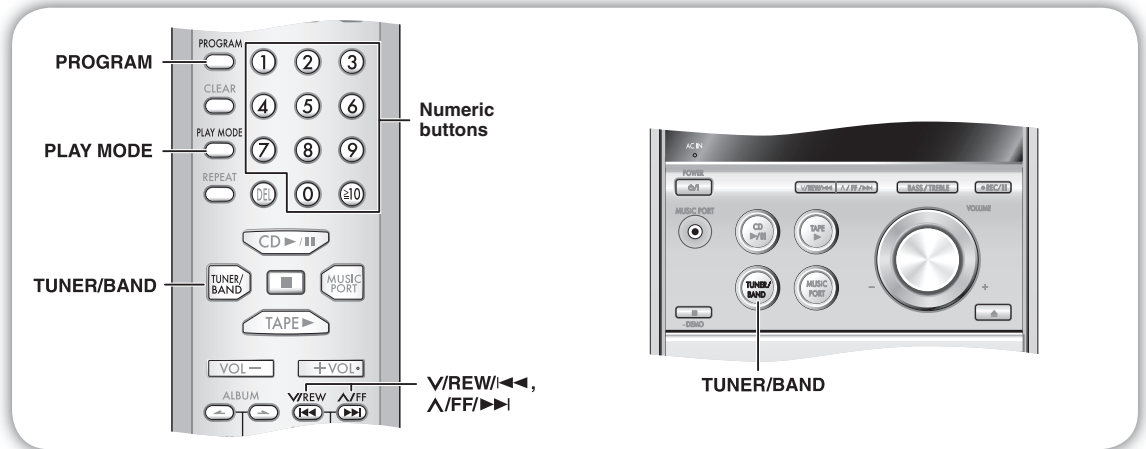

Manual tuning

- 1 Press [TUNER/BAND] to select “FM” or “AM”.
- 2 Press [PLAY MODE] to select “MANUAL”.
- 3 Press [V/REW/◀◀] or [^/FF/▶▶] to select the frequency of the required station.

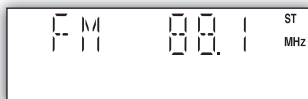

“ST” is displayed when a stereo FM broadcast is being received.

To tune automatically

Press [V/REW/◀◀] or [^/FF/▶▶] for a moment until the frequency starts changing rapidly. The unit begins auto tuning, stopping when it finds a station.

- Auto tuning may not function when there is excessive interference.
- To cancel auto tuning, press [V/REW/◀◀] or [^/FF/▶▶] once again.

To improve FM sound quality

Press and hold [PLAY MODE] to display “MONO”.

To cancel

Press and hold [PLAY MODE] again until “MONO” disappears.

- MONO is also canceled if the frequency is changed.
- Turn off “MONO” for normal listening.

Memory preset

Up to 15 stations can be set in both the FM and AM bands.

Preparation

Press [TUNER/BAND] to select “FM” or “AM”.

Automatic presetting

Press and hold [PROGRAM] to start presetting.

Manual presetting

- 1 Press [PLAY MODE] to select “MANUAL”.
- 2 Press [V/REW/◀◀] or [^/FF/▶▶] to tune to the required station.
- 3 Press [PROGRAM].
- 4 Press numeric buttons to select a channel. The station occupying a channel is erased if another station is preset in that channel.
- 5 Repeat steps 2 to 4 to preset more stations.

Selecting a preset station

Press numeric buttons to select the channel.

For channels 10 to 15 press [≥10], then the two digits.

OR

- 1 Press [PLAY MODE] to select “PRESET”.
- 2 Press [V/REW/◀◀] or [^/FF/▶▶] to select the channel.

FM allocation setting

By main unit only

This system can also receive FM broadcasts allocated in 0.1 MHz steps.

To change the step to 0.1 MHz

- 1 Press and hold [TUNER/BAND]. After a few seconds the display changes to a flashing display of the current minimum frequency.
- 2 Continue to hold down [TUNER/BAND].
 - When the minimum frequency changes, release the button. To return to the original step, repeat the above steps.
 - After the setting is changed, any previously preset frequency will be cleared.

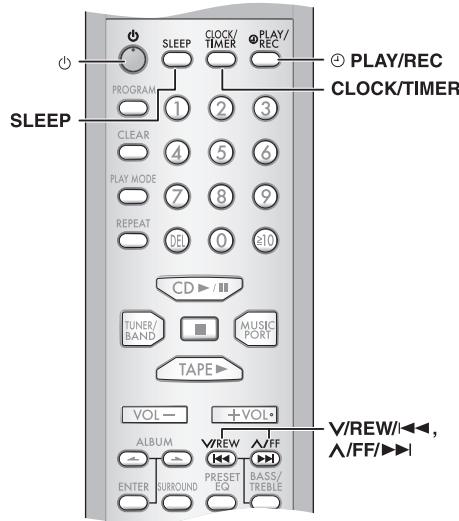

Setting the clock

This is a 12-hour clock.

- 1 Press [CLOCK/TIMER] to select "CLOCK".
Each time you press the button:

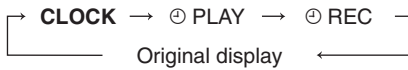

- 2 Within 5 seconds, press [V/REW/FF] or [^/FF/FF] to set the time.



- 3 Press [CLOCK/TIMER] again to confirm.

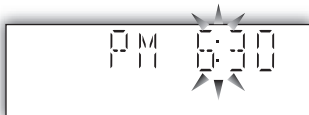

Displaying the clock

Press [CLOCK/TIMER] to display the clock for few seconds.

Note

The clock may lose or gain minutes over a period of time. Readjust as necessary.

Using the sleep timer

This function enables you to turn off the unit automatically after the set time.

Press [SLEEP] repeatedly to select your desired time.

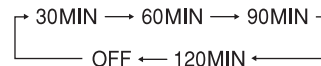

Sleep timer indicator

To cancel

Press [SLEEP] to select "OFF".

Changing the remaining time

Press [SLEEP] to show the remaining time, and press [SLEEP] again to select your desired time.

Note

- The play and sleep timer or the record and sleep timer can be used together.
- The sleep timer always has priority. Be sure not to overlap timer settings.

Using the play or record timer

You can set the timer to come on at a certain time to wake you up (play timer) or to record from the radio or music port source (record timer).

Preparation

Turn the unit on and set the clock (refer to page 11).

Timer	Action
Play timer	Prepare the music source you want to listen to; cassette, disc, radio or music port source, and set the volume.
Record timer	Check the cassette's erasure prevention tabs (refer to page 9), insert the cassette and tune to the radio station (refer to page 10) or select the music port source (refer to page 13).

1 Press [CLOCK/TIMER] repeatedly to select your desired timer.



2 Within 5 seconds, press [√/REW/◀◀] or [^/FF/▶▶] to set the starting time.

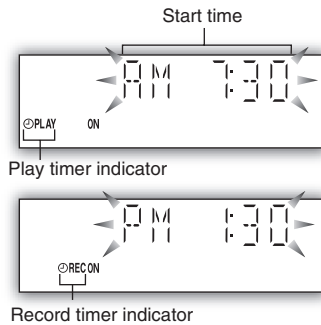

3 Press [CLOCK/TIMER] to confirm.

4 Repeat steps 2 and 3 to set the finishing time.

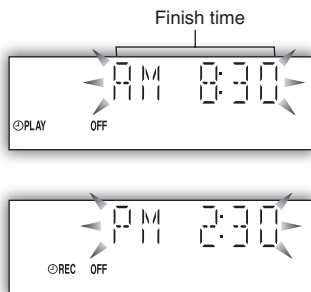

To activate the timer

5 Press [⊕PLAY/REC] to turn on your desired timer.



6 Press [⏻] to turn off the unit.

The unit must be off for the timers to operate.

Other basic operations

To	Action
change the settings	Repeat steps 1 to 4 and 6.
change the source or volume	1) Press [⊕PLAY/REC] to clear the timer indicator from the display. 2) Make changes to the source or volume. 3) Perform steps 5 and 6.
check the settings (when the unit is on or in standby mode)	Press [CLOCK/TIMER] repeatedly to select ⊕PLAY or ⊕REC.
cancel	Press [⊕PLAY/REC] to clear the timer indicators from the display.

Note

- The play timer and record timer cannot be used together.
- The play timer will start at the preset time, with the volume increasing gradually to the preset level.
- The record timer will start 30 seconds before the set time, with the volume muted.
- The timer comes on at the set time every day if the timer is on.
- The unit must be in the standby mode for the timer to function.
- If you turn the unit off and on again while a timer is functioning, the finish time setting will not be activated.
- If MUSIC PORT is selected as the source when the timer comes on, the system turns on and engages MUSIC PORT as the source. If you wish to playback or record from the portable audio equipment, activate the equipment's play mode and increase the volume. (See the portable audio equipment's instruction manual.)

Sound adjustment

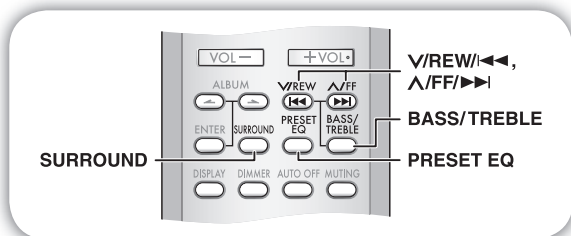

Selecting sound effects

You can change the sound effect by selecting Preset EQ or adjusting the bass or treble effect.

Preset EQ

Press [PRESET EQ] repeatedly to select your desired setting.

HEAVY → CLEAR → SOFT → VOCAL → EQ-OFF
 ↙ ↘ ↙ ↘ ↙ ↘ ↙ ↘ ↙ ↘

Setting	Effect
HEAVY	Adds punch to rock
CLEAR	Clarifies higher frequencies
SOFT	For background music
VOCAL	Adds gloss to vocal
EQ-OFF	No effect

Bass or treble

Enable you to enjoy the lower or higher pitch sound.

- 1 Press [BASS/TREBLE] repeatedly to select your desired setting.

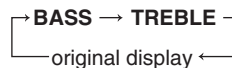

Setting	Effect
BASS	For lower pitch sound
TREBLE	For higher pitch sound

- 2 Press [V/REW/◀◀] or [A/FF/▶▶] to adjust the level.

Note

The tone level can be varied within -4 to +4.

Enjoying surround-sound

Enable you to add natural width and depth to the stereo sound.

To activate

Press [SURROUND] to display “■■■■■” indicator.

To cancel

Press [SURROUND] again to clear “■■■■■” indicator.

Note

- Surround-sound is less discernible when listening through headphones.
- If interference in FM stereo reception increases, cancel the surround-sound effect.

External unit

Connecting to a portable audio equipment

This feature enables you to enjoy music from portable audio equipment.

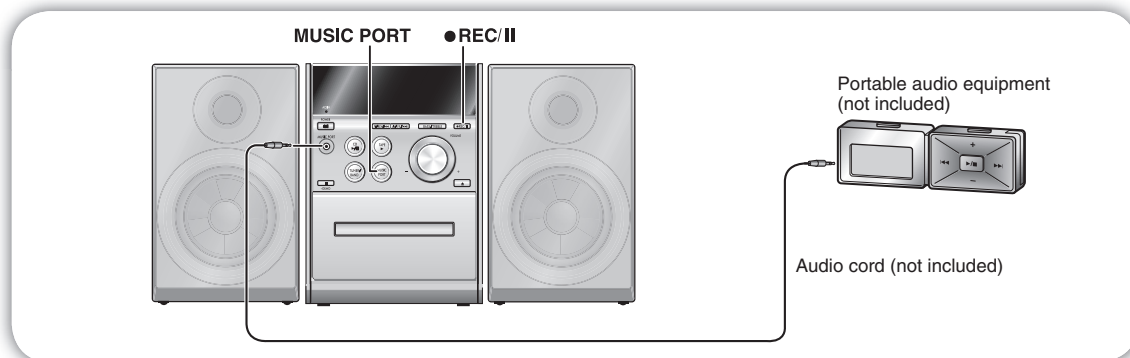

Playing from portable audio equipment

Switch off the equalizer function (if there is any) of the portable audio equipment before you plug into the MUSIC PORT jack. Otherwise, sound from the speaker may be distorted.

- 1 Plug the audio cord into the MUSIC PORT jack and press [MUSIC PORT].
- 2 Play the portable audio equipment. (See the portable audio equipment's instruction manual.)

Note

All peripheral components and cables are sold separately.

Recording from portable audio equipment

- 1 Insert the cassette to be recorded.
- 2 Press [MUSIC PORT].
- 3 Play the portable audio equipment.
- 4 Press [● REC/II] to start recording.

Note

For other recording operations, refer to page 9, “Other basic operations”.

Troubleshooting guide

Before requesting service, make the following checks. If you are in doubt about some of the check points, or if the remedies indicated in the chart do not solve the problem, refer to the “Customer Services Directory” on page 16 if you reside in the U.S.A., or refer to the “Product information” on page 17 if you reside in Canada.

Common problems

No sound.	Turn the volume up. The speaker cords may not be connected properly. Turn the unit off, check and correct the connections and turn the unit on (refer to page 4).
Sound is unfixed, reversed or comes from one speaker only.	Check the speaker connections (refer to page 4).
Humming heard during play.	An AC power supply cord or fluorescent light is near the cables. Keep other appliances and cords away from this unit's cables.
“ERROR” is displayed.	Incorrect operation performed. Read the instructions and try again.
“--:--” appears on the display.	You plugged the AC power supply cord in for the first time or there was a power failure recently. Set the time (refer to page 11).
“F76” is displayed.	Check and correct the speaker cord connections (refer to page 4). If this does not fix the problem, there is a power supply problem. Consult the dealer.

Listening to the radio

Noise is heard. The stereo indicator flickers or doesn't light. Sound is distorted.	Use an outdoor antenna (refer to page 4).
A beat sound is heard.	Turn the TV off or separate it from the unit.
A low hum is heard during AM broadcast.	Separate the antenna from other cables and cords.

When there is a television set nearby

The picture on the TV disappears or stripes appear on the screen.	The location and direction of the antenna are incorrect. If you are using an indoor antenna, change to an outdoor antenna (refer to page 4). The TV antenna wire is too close to the unit. Separate the antenna wire of the TV set from the unit.
---	--

Using the cassette deck

Recording is not possible.	If the erasure prevention tabs have been removed, cover the holes with adhesive tape (refer to page 9).
----------------------------	---

Playing discs

The display is wrong or play won't start.	The disc may be upside down (refer to page 7). Wipe the disc. Replace the disc if it is scratched, warped, or non-standard. Condensation may have formed inside the unit due to a sudden change in temperature. Wait about an hour for it to clear and try again.
---	--

The remote control

Remote control doesn't work.	Check that the batteries are inserted correctly (refer to page 5). Replace the batteries if they are worn.
------------------------------	---

Specifications

AMPLIFIER SECTION

FTC OUTPUT POWER both channel driven simultaneously	
10% total harmonic distortion	
60 Hz to 20 kHz	18 W per channel (6Ω)
RMS OUTPUT POWER both channel driven simultaneously	
10% total harmonic distortion	
1 kHz	20 W per channel (6Ω)
Input impedance	
Music Port	250 mV 12 kΩ
Output impedance	
HEADPHONE	16 Ω to 32 Ω
Phone jack	
Terminal	Stereo, 3.5 mm
Music Port input jack	
Terminal	Stereo, 3.5 mm

FM TUNER SECTION

Frequency range	
	87.9 MHz to 107.9 MHz (200 kHz steps)
	87.5 MHz to 108.0 MHz (100 kHz steps)
Sensitivity	
S/N 26 dB	1.5 μV (IHF)
	1.0 μV
Antenna terminals	75 Ω (unbalanced)
Preset station	FM 15 stations AM 15 stations

AM TUNER SECTION

Frequency range	520 kHz to 1710 kHz (10 kHz steps)
Sensitivity	
S/N 20 dB (at 1000 kHz)	447 μV/m

CASSETTE DECK SECTION

Track system	4-track, 2-channel
Heads	
Record/playback	Solid permalloy head
Erasure	Double gap ferrite head
Motor	DC servo motor
Recording system	AC bias 100 kHz
Erase system	AC erase 100 kHz
Tape speed	4.8 cm/s (1 ⁷ / ₈ ips)
Overall frequency response (+3, -6 dB) at DECK OUT	
Normal	35 Hz to 14 kHz
S/N RATIO	47 dB (A weighted)
Wow and flutter	0.08 % (WRMS)
Fast-forward and rewind time	
	Approx. 120 seconds with C-60 cassette tape

CD SECTION

Disc played [8 cm (3") or 12 cm (5")]	
(1) CD-Audio (CD-DA)	
(2) CD-R/RW (CD-DA, MP3, WMA formatted disc)	
(3) MP3/WMA	
Sampling frequency	
CD	44.1 kHz
MP3/WMA	32 kHz, 44.1 kHz, 48 kHz
Bit rate	
MP3/WMA	32 kbps to 384 kbps
Decoding	16/20/24 bit linear
Pick up	
Wavelength	785 nm
Beam source	Semiconductor laser
Laser power	CLASS 1
Audio output (Disc)	
Number of channels	2-channel
Frequency response	20 Hz to 20 kHz (+1 dB, -2 dB)
Wow and flutter	Below measurable limit
Digital filter	8 fs
D/A converter	MASH (1 bit DAC)

SPEAKER SECTION

Type	1 way, 1 speaker system
Speaker(s)	
FULL RANGE	10 cm (4") twin cone type (6Ω)
Impedance	6 Ω
Input power (IEC)	20 W (Max)
Output sound pressure	83 dB/W (1.0 m)
Frequency range	51 Hz to 23 kHz (-16 dB)
	83 Hz to 22 kHz (-10 dB)
Dimensions (W x H x D)	139 mm x 227 mm x 136 mm (5 ¹⁵ / ₃₂ " x 8 ¹⁵ / ₁₆ " x 5 ¹¹ / ₃₂ "
Mass	1.3 kg (2.9 lb.)

GENERAL

Power supply	AC 120 V, 60 Hz
Power consumption	57 W
Dimensions (W x H x D)	165 mm x 227 mm x 285 mm (6 ¹ / ₂ " x 8 ¹⁵ / ₁₆ " x 11 ¹ / ₈ "
Mass	3.2 kg (7.1 lb.)
Operating temperature range	+5°C to +35°C (+41°F to +95°F)
Operating humidity range	5 % to 90 % RH (no condensation)

Power consumption in standby mode 0.6 W

Note

- Specifications are subject to change without notice. Mass and dimensions are approximate.
- Total harmonic distortion is measured by the digital spectrum analyzer.

Maintenance

If the surfaces are dirty

To clean this unit, wipe with a soft, dry cloth.

- Never use alcohol, paint thinner or benzine to clean this unit.
- Before using chemically treated cloth, read the instructions that came with the cloth carefully.

For a cleaner, crisper sound

Clean the heads regularly to assure good quality playback and recording.
Use a cleaning tape (not included).

Limited Warranty (ONLY FOR U.S.A.)

Panasonic Consumer Electronics Company,
Division of Panasonic Corporation of North America
One Panasonic Way Secaucus, New Jersey 07094

Panasonic Puerto Rico, Inc.
Ave. 65 de Infantería, Km. 9.5
San Gabriel Industrial Park, Carolina, Puerto Rico 00985

Panasonic Audio Products Limited Warranty

Limited Warranty Coverage

If your product does not work properly because of a defect in materials or workmanship, Panasonic Consumer Electronics Company or Panasonic Puerto Rico, Inc. (collectively referred to as "the warrantor") will, for the length of the period indicated on the chart below, which starts with the date of original purchase ("warranty period"), at its option either (a) repair your product with new or refurbished parts, or (b) replace it with a new or a refurbished product. The decision to repair or replace will be made by the warrantor.

Product or Part Name	Parts	Labor
Audio Products (except items listed below)	One (1) year	One (1) year
USB Reader-Writer, Personal Computer Card Adapters (in exchange for defective item)	One (1) year	Not Applicable
Accessories: Headphones, Cartridges, Microphones, Adapters	Ninety (90) days	Ninety (90) days
Rechargeable Batteries, DVD-R/-RAM Discs (in exchange for defective item)	Ten (10) days	Not Applicable
SD Memory Cards, Rechargeable Battery Packs (in exchange for defective item)	Ninety (90) days	Not Applicable

During the "Labor" warranty period there will be no charge for labor. During the "Parts" warranty period, there will be no charge for parts. You must carry-in or mail-in your product during the warranty period. If non-rechargeable batteries are included, they are not warranted. This warranty only applies to products purchased and serviced in the United States or Puerto Rico. This warranty is extended only to the original purchaser of a new product which was not sold "as is". A purchase receipt or other proof of the original purchase date is required for warranty service.

Carry-In or Mail-In Service

For Carry-In or Mail-In Service in the United States call 1-800-211-PANA (1-800-211-7262) or visit Panasonic web site: <http://www.panasonic.com> For assistance in Puerto Rico call Panasonic Puerto Rico, Inc. (787)-750-4300 or fax (787)-768-2910.

Limited Warranty Limits And Exclusions

This warranty ONLY COVERS failures due to defects in materials or workmanship, and DOES NOT COVER normal wear and tear or cosmetic damage. The warranty ALSO DOES NOT COVER damages which occurred in shipment, or failures which are caused by products not supplied by the warrantor, or failures which result from accidents, misuse, abuse, neglect, mishandling, misapplication, alteration, faulty installation, set-up adjustments, misadjustment of consumer controls, improper maintenance, power line surge, lightning damage, modification, or commercial use (such as in a hotel, office, restaurant, or other business), rental use of the product, service by anyone other than a Factory Servicenter or other Authorized Servicicer, or damage that is attributable to acts of God.

THERE ARE NO EXPRESS WARRANTIES EXCEPT AS LISTED UNDER "LIMITED WARRANTY COVERAGE". THE WARRANTOR IS NOT LIABLE FOR INCIDENTAL OR CONSEQUENTIAL DAMAGES RESULTING FROM THE USE OF THIS PRODUCT, OR ARISING OUT OF ANY BREACH OF THIS WARRANTY. (As examples, this excludes damages for lost time, travel to and from the servicicer, loss of media or images, data or other memory content. The items listed are not exclusive, but are for illustration only.) **ALL EXPRESS AND IMPLIED WARRANTIES, INCLUDING THE WARRANTY OF MERCHANTABILITY, ARE LIMITED TO THE PERIOD OF THE LIMITED WARRANTY.**

Some states do not allow the exclusion or limitation of incidental or consequential damages, or limitations on how long an implied warranty lasts, so the exclusions may not apply to you.

This warranty gives you specific legal rights and you may also have other rights which vary from state to state. If a problem with this product develops during or after the warranty period, you may contact your dealer or Servicicer. If the problem is not handled to your satisfaction, then write to the warrantor's Consumer Affairs Department at the addresses listed for the warrantor.

PARTS AND SERVICE WHICH ARE NOT COVERED BY THIS LIMITED WARRANTY ARE YOUR RESPONSIBILITY.

Customer Services Directory

Obtain Product Information and Operating Assistance; locate your nearest Dealer or Servicicer; purchase Parts and Accessories; or make Customer Service and Literature requests by visiting our Web Site at:

<http://www.panasonic.com/consumersupport>
or, contact us via the web at:

<http://www.panasonic.com/contactinfo>

You may also contact us directly at:

1-800-211-PANA (7262),

Monday-Friday 9 am-9 pm; Saturday-Sunday 10 am-7 pm, EST.

For hearing or speech impaired TTY users, TTY: 1-877-833-8855

Accessory Purchases

Purchase Parts, Accessories and Instruction Books online for all Panasonic Products by visiting our Web Site at:

<http://www.pasc.panasonic.com>

or, send your request by E-mail to:

npcparts@us.panasonic.com

You may also contact us directly at:

1-800-332-5368 (Phone) 1-800-237-9080 (Fax Only) (Monday-Friday 9 am to 8 pm, EST.)

Panasonic Services Company

20421 84th Avenue South, Kent, WA 98032

(We Accept Visa, MasterCard, Discover Card, American Express, and Personal Checks)

For hearing or speech impaired TTY users, TTY: 1-866-605-1277

Service in Puerto Rico

Panasonic Puerto Rico, Inc.

Ave. 65 de Infantería, Km. 9.5, San Gabriel Industrial Park, Carolina, Puerto Rico 00985

Phone (787)750-4300, Fax (787)768-2910

Limited Warranty (ONLY FOR CANADA)

Panasonic Canada Inc.

PANASONIC/TECHNICS PRODUCT – LIMITED WARRANTY

Panasonic Canada Inc. warrants this product to be free from defects in material and workmanship and agrees to remedy any such defect for a period as stated below from the date of original purchase.

Technics Audio Product	One (1) year, parts and labour
Panasonic Audio & DVD Product	One (1) year, parts and labour
Accessories including rechargeable batteries	Ninety (90) days

In-home Service will be carried out only to locations accessible by roads and within 50 km of an authorized Panasonic service facility.

LIMITATIONS AND EXCLUSIONS

This warranty does not apply to products purchased outside Canada or to any product which has been improperly installed, subjected to usage for which the product was not designed, misused or abused, damaged during shipping, or which has been altered or repaired in any way that affects the reliability or detracts from the performance, nor does it cover any product which is used commercially. Dry cell batteries are also excluded from coverage under this warranty.

This warranty is extended to the original end user purchaser only. A purchase receipt or other proof of date of original purchase is required before warranty service is performed.

THIS EXPRESS, LIMITED WARRANTY IS IN LIEU OF ALL OTHER WARRANTIES, EXPRESS OR IMPLIED, INCLUDING ANY IMPLIED WARRANTIES OF MERCHANTABILITY AND FITNESS FOR A PARTICULAR PURPOSE. IN NO EVENT WILL PANASONIC CANADA INC. BE LIABLE FOR ANY SPECIAL, INDIRECT OR CONSEQUENTIAL DAMAGES.

In certain instances, some jurisdictions do not allow the exclusion or limitation of incidental or consequential damages, or the exclusion of implied warranties, so the above limitations and exclusions may not be applicable.

WARRANTY SERVICE

FOR PRODUCT OPERATION ASSISTANCE, please contact:

Our Customer Care Centre:	Telephone #:	(905) 624-5505
	1-800 #:	1-800-561-5505
	Fax #:	(905) 238-2360
	Email link:	"Contact Us" on www.panasonic.ca

FOR PRODUCT REPAIRS, please locate your nearest Authorized Servicente at www.panasonic.ca:

Link: "Servicentres™ locator" under "Customer support"

Panasonic Factory Service:

<u>Richmond British Columbia</u>	<u>Mississauga Ontario</u>
Panasonic Canada Inc.	Panasonic Canada Inc.
12111 Riverside Way	5770 Ambler Drive
Richmond BC V6W 1K8	Mississauga ON L4W 2T3
Tel: (604) 278-4211	Tel: (905) 624-8447
Fax: (604) 278-5627	Fax: (905) 238-2418

IF YOU SHIP THE PRODUCT TO A SERVICENTRE

Carefully pack and send prepaid, adequately insured and preferably in the original carton. Include details of the defect claimed, and proof of date of original purchase.

Product Service

- 1. Damage requiring service**– The unit should be serviced by qualified service personnel if:
 - (a) The AC power supply cord or the plug has been damaged; or
 - (b) Objects or liquids have gotten into the unit; or
 - (c) The unit has been exposed to rain; or
 - (d) The unit does not operate normally or exhibits a marked change in performance; or
 - (e) The unit has been dropped or the cabinet damaged.
- 2. Servicing**– Do not attempt to service the unit beyond that described in these operating instructions. Refer all other servicing to authorized servicing personnel.
- 3. Replacement parts**– When parts need replacing ensure the servicer uses parts specified by the manufacturer or parts that have the same characteristics as the original parts. Unauthorized substitutes may result in fire, electric shock, or other hazards.
- 4. Safety check**– After repairs or service, ask the servicer to perform safety checks to confirm that the unit is in proper working condition.

The servicer will require all components to service your system. Therefore, should service ever be necessary, be sure to bring the entire system.

Product information

For product information or assistance with product operation:

In the U.S.A., refer to "Customer Services Directory" on page 16.

In Canada, contact the Panasonic Canada Inc. Customer Care Centre at 905-624-5505, or visit the website (www.panasonic.ca), or an authorized Servicentre closest to you.

Preparativos iniciales

Referirse a las páginas 4 y 5 para las ilustraciones.

Paso 1 - Conexiones

Conecte el cable de alimentación de CA sólo después de haber hecho todas las demás conexiones.

1 Conecte la antena de cuadro de AM.

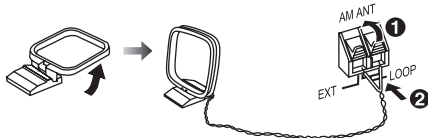

Ponga la antena en posición vertical sobre su base.

2 Conecte la antena interior de FM.

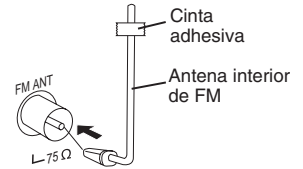

Fije la antena en una pared o columna en una posición en que la señal de radio se reciba con las menores interferencias.

3 Conecte los cables de los altavoces.

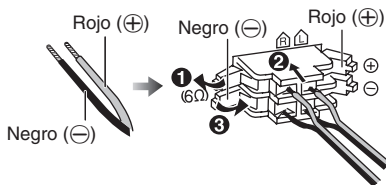

Una conexión incorrecta puede dañar el aparato.

4 Conecte el cable de alimentación de CA.

El cable de alimentación de CA incluido es para ser usado con este aparato solamente. No lo utilice con otro equipo.

Paso 2 - Introducción de pilas en el mando a distancia

■ Pilas

- Inserte los polos (+ y -) de la forma que se indica en el mando a distancia.
- Retire las pilas si no va a utilizar el mando a distancia durante un periodo de tiempo largo. Guárdelas en un lugar fresco y oscuro.
- No utilice baterías recargables.
- Un mal manejo de pilas en el control remoto puede provocar fugas electrolíticas, que pueden provocar fuego.

■ Utilización

Diríjalo al sensor del mando a distancia, evitando los obstáculos, desde una distancia máxima de 7 m (23 pies) directamente delante del aparato.

Consulte la página 19 para ver la posición del sensor de la señal del mando a distancia.

Paso 3 - Función de demostración

Cuando el aparato se enchufe por primera vez puede aparecer en el visualizador una demostración de sus funciones.

Si el ajuste de demostración está desactivado, usted podrá activarlo seleccionando "DEMO ON".

Mantenga pulsado [■, -DEMO].

La visualización cambia cada vez que se pulsa el botón.

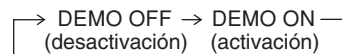

Durante el modo de espera, seleccione "DEMO OFF" para reducir el consumo de energía.

Colocación de los altavoces

Los altavoces han sido diseñados idénticamente por lo que no es necesario orientar el canal derecho o izquierdo.

Utilice solamente los altavoces suministrados.

La combinación de la unidad principal y los altavoces proporcionan el mejor sonido. Utilizando otros altavoces se puede estropear la unidad y el sonido quedará afectado negativamente.

Nota

- Mantenga sus altavoces alejados un mínimo de 10 mm ($13/32$ "") del sistema para tener una ventilación apropiada.
- Estos altavoces no disponen de blindaje magnético. No los ponga cerca de televisores, ordenadores personales u otros dispositivos a los que afecte fácilmente el magnetismo.
- No quite la rejilla frontal de los altavoces.



Precaución

- Use los altavoces sólo con el sistema recomendado. De lo contrario, se podrían dañar el amplificador y los altavoces, y se podría ocasionar un incendio. Consulte a un técnico de servicio especializado si se ha producido algún daño o si se ha producido un cambio repentino en su funcionamiento.
- No instale estos altavoces en paredes ni techos.

Controles

Aparato principal

Los números entre paréntesis indican la página de referencia.

Parte superior del aparato



Toma de auriculares (PHONES)
Procure evitar utilizarlos durante un periodo de tiempo prolongado con el fin de evitar lesiones auditivas.
Tipo de clavija: estéreo de 3,5 mm (1/8") (no suministrada)

Tapa del disco (7, 9)

Abrir/cerrar tapa del disco (20)

Sensor de señal del mando a distancia

Indicador de alimentación de CA (AC IN)
Este indicador se encenderá cuando el aparato esté conectado a la red de CA.

1 Interruptor de alimentación en espera/conectada (⏻/I, POWER) (20, 23)

Pulse este interruptor para cambiar del modo de alimentación conectada al modo de alimentación en espera o viceversa. En el modo de alimentación en espera el aparato consume una pequeña cantidad de corriente.

Nota:

La unidad tarda unos segundos en encenderse después de conectarla a la toma de corriente AC.

Conector de puerto de música (13)

2 Reproducción/pausa de disco (20)

3 Reproducción de la cinta (21)

Paro/demostración (8, 18, 20, 21)

Soporte de casete (21)

Visualizador

4 Selección de graves/agudos (13)

Inicio/pausa de grabación (13, 21)

Omitir/buscar disco, avance rápido de cinta/rebobinar, sintonizar/selección de canal presintonizado, ajuste de tiempo, ajuste de graves/agudos

5 Control de volumen

Abra la tapa del casete (21)

6 Selección de puerto de música (13)

7 Selector de sintonizador/banda (22)

Mando a distancia

Los botones como el **1** funcionan del mismo modo que los botones del aparato principal.

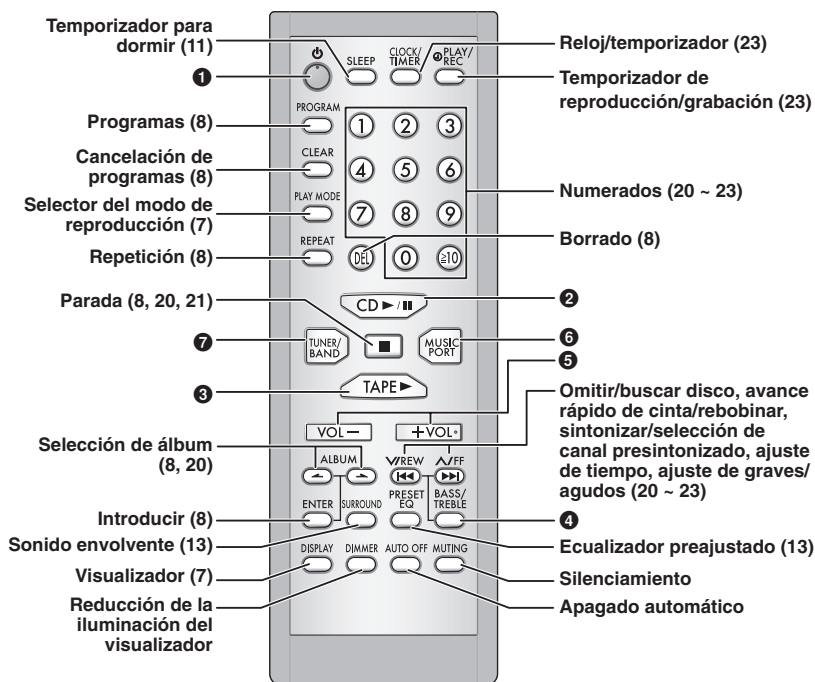

AUTO OFF Esta función de apagado automático le permite apagar el aparato en modo **disco o cinta**, sólo después de 10 minutos sin utilizarlo.

El ajuste se mantiene aunque el aparato esté apagado.

DIMMER Para reducir la iluminación del visualizador.

MUTING Para silenciar el sonido.

- Pulse el botón para activarlo.
- Vuélvalo a pulsar para cancelar.

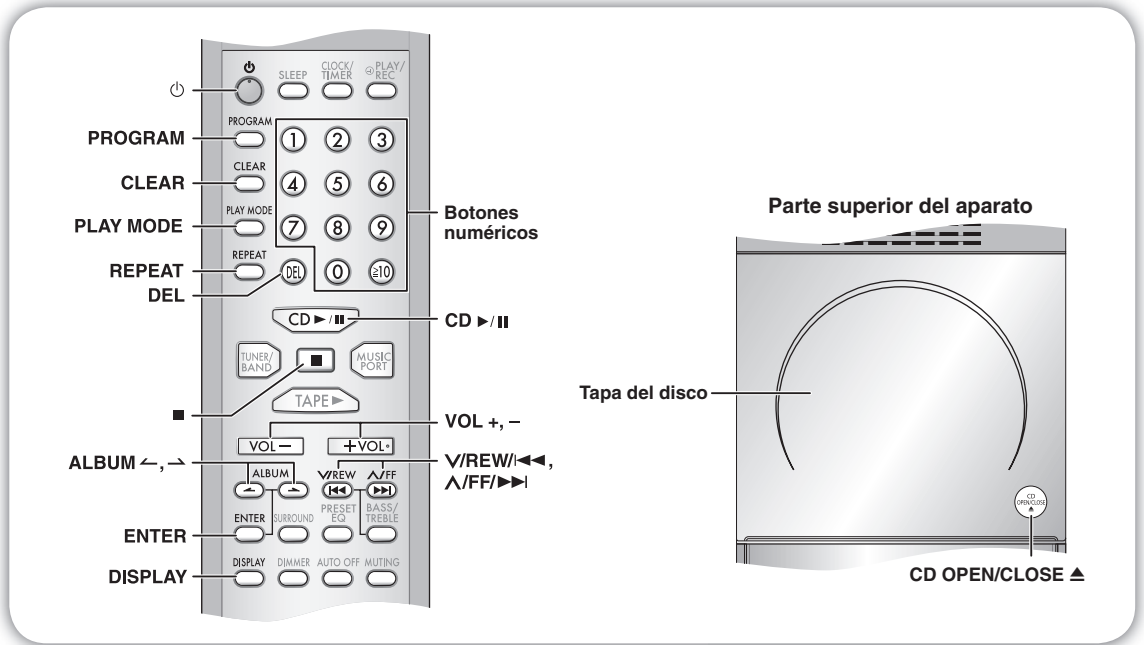

Reproducción básica

CD MP3 WMA

- 1 Pulse [⏻] para encender el aparato.
- 2 Pulse [CD OPEN/CLOSE ▲] para abrir la tapa del disco e inserte el disco. Cierre la tapa.

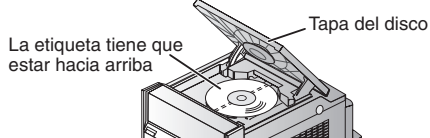

- 3 Pulse [CD ▶/||] para iniciar la reproducción.
- 4 Ajuste el volumen.

Para	Acción
detener el disco	Pulse [■].
interrumpir la reproducción	Pulse [CD ▶/]. Vuelva a pulsar para reanudar la reproducción.
saltar pistas	Pulse [V/REW/◀◀] o [∧/FF/▶▶].
buscar por pistas	Mantenga pulsado [V/REW/◀◀] o [∧/FF/▶▶] durante la reproducción o la pausa.
saltar álbum	Pulse [ALBUM ◀ o ▶] en el modo de reproducción. Pulse [ALBUM ◀ o ▶] una vez y los botones numéricos en el modo de parada.

CD

MP3 WMA

Función de modo de reproducción

CD MP3 WMA

- 1 Pulse [CD ▶/||].
- 2 Pulse [PLAY MODE] para seleccionar el modo deseado.

Modo	Para reproducir
1-TRACK 1TR	una melodía seleccionada del disco. Pulse las teclas numéricas para seleccionar la pista.
1-ALBUM 1ALBUM MP3 WMA	un álbum seleccionado del disco. Pulse [ALBUM ◀ o ▶] para seleccionar el álbum.
RANDOM RND	un disco aleatoriamente.
1-ALBUM RANDOM 1ALBUM RND MP3 WMA	todas las pistas de un álbum seleccionado aleatoriamente. Pulse [ALBUM ◀ o ▶] para seleccionar el álbum.

Nota

- Durante la reproducción RANDOM o 1-ALBUM RANDOM, no puede saltar pistas que ya han sido reproducidas.

CD

- Durante la reproducción RANDOM, podrá buscar hacia delante o hacia atrás dentro de la pista actual solamente.

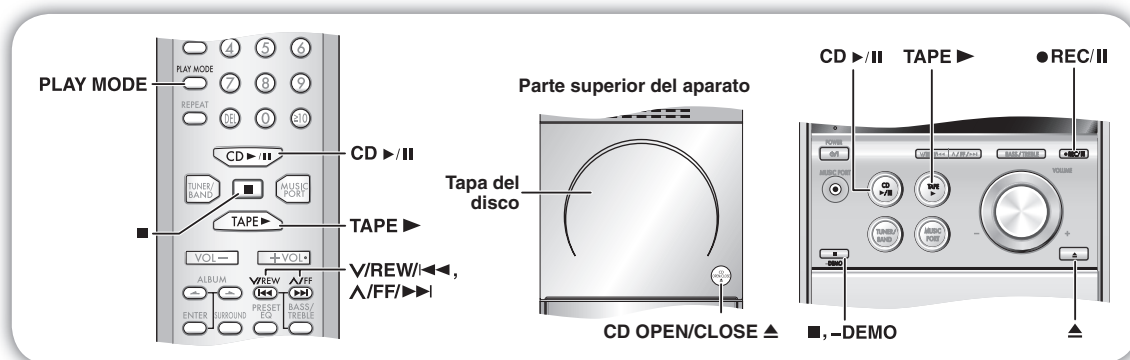

Reproducción básica

1 Pulse [▲] e insertar la cinta.

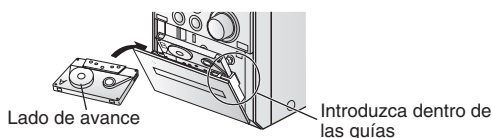

2 Cierre la tapa con la mano.

3 Pulse [TAPE >] para iniciar la reproducción.

Para reproducir la otra cara de la cinta, dé la vuelta al casete.

Para	Acción
detener la reproducción	Pulse [■].
iniciar la reproducción con una pulsación	Pulse [TAPE >] cuando el sistema esté apagado con el casete cargado.
avanzar rápidamente o rebobinar	Pulse [V/REW/◀◀] o [^/FF/▶▶] el modo de parada.

Grabación

Use cintas de posición normal.

Pueden usarse cintas de posición alta y de metal, pero el aparato no las grabará ni las borrará correctamente.

Preparación

Rebobine la cinta original para que la grabación pueda comenzar de inmediato.

Grabación de discos

- 1 Introduzca el casete en el que quiera grabar.
- 2 Pulse [CD OPEN/CLOSE ▲] para insertar el disco y cierre la tapa.
- 3 Pulse [CD >||] y luego [■, -DEMO].
- 4 Pulse [PLAY MODE] para seleccionar el modo deseado (consulte la página 20).
- 5 Pulse [● REC/||] para iniciar la grabación.

Otras operaciones básicas

Para	Acción
detener la grabación	Pulse [■].
grabar en la otra cara de la cinta	Dé la vuelta a la cinta de casete y pulse [● REC/].

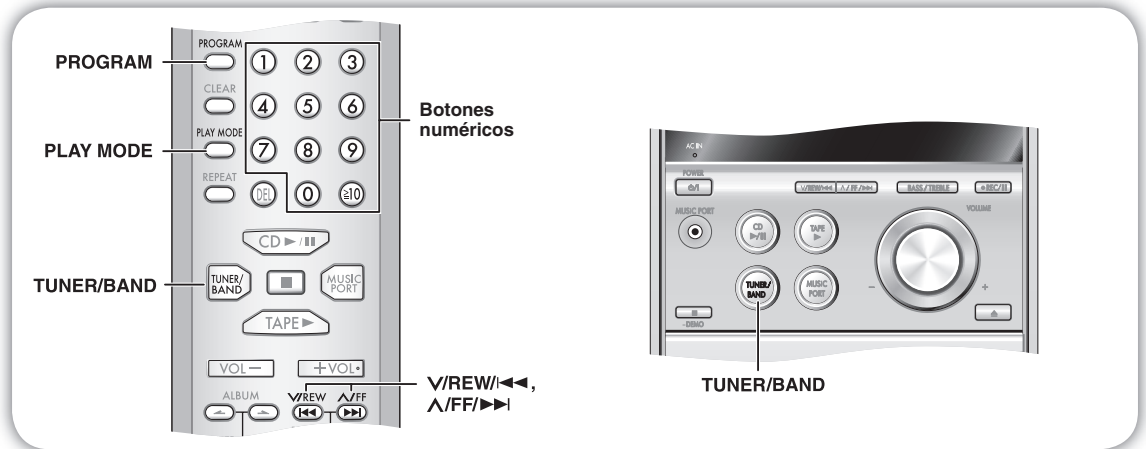

Sintonización manual

- 1 Pulse [TUNER/BAND] para seleccionar "FM" o "AM".
- 2 Pulse [PLAY MODE] para seleccionar "MANUAL".
- 3 Pulse [V/REW/◀◀] o [^/FF/▶▶] para seleccionar la frecuencia de la emisora requerida.

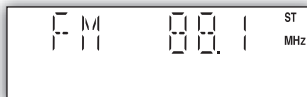

Se visualizará "ST" cuando esté siendo recibida una emisora estéreo por FM.

Para sintonizar automáticamente

Pulse [V/REW/◀◀] o [^/FF/▶▶] hasta que la frecuencia empiece a cambiar rápidamente. El aparato inicia la sintonización automática y se detendrá cuando encuentre una emisora.

- La sintonización automática tal vez se interrumpa cuando las interferencias sean excesivas.
- Para cancelar la sintonización automática, pulse una vez más [V/REW/◀◀] o [^/FF/▶▶].

Para mejorar la calidad del sonido de FM

Mantenga pulsado [PLAY MODE] para visualizar "MONO".

Para cancelar

Mantenga pulsado [PLAY MODE] otra vez hasta que "MONO" desaparezca.

- MONO también se cancelará si se cambia la frecuencia.
- Deje "MONO" apagado para la escucha normal.

Grabación de emisoras en memoria

Se puede presintonizar un máximo de 15 emisoras en cada banda, FM y AM.

Preparación

Pulse [TUNER/BAND] para seleccionar "FM" o "AM".

Presintonización automática

Mantenga pulsado [PROGRAM] para iniciar la presintonización.

Presintonización manual

- 1 Pulse [PLAY MODE] para seleccionar "MANUAL".
- 2 Pulse [V/REW/◀◀] o [^/FF/▶▶] para seleccionar la emisora deseada.
- 3 Pulse [PROGRAM].
- 4 Pulse los botones numéricos para seleccionar el canal. La emisora que ocupa un canal se borrará si se presintoniza otra emisora en ese canal.
- 5 Repita los pasos del 2 al 4 para preestablecer más emisoras.

Selección de una emisora presintonizada

Pulse los botones numéricos para seleccionar el canal. Para los canales 10 a 15 pulse [≥10] y después los dos dígitos. 0

- 1 Pulse [PLAY MODE] para seleccionar "PRESET".
- 2 Pulse [V/REW/◀◀] o [^/FF/▶▶] para seleccionar el canal.

Ajuste de la asignación de FM

Aparato principal solamente

Este sistema le permite recibir emisiones de FM asignadas en pasos de 0,1 MHz.

Para cambiar el paso a 0,1 MHz

- 1 Mantenga pulsado [TUNER/BAND]. Después de unos segundos, la visualización cambiará a una visualización parpadeante de la frecuencia mínima actual.
- 2 Continúe pulsando [TUNER/BAND].
 - Si la frecuencia mínima cambia, suelte el botón. Para volver al paso original, repita los pasos anteriores.
 - Después de cambiar el ajuste de "asignación", las frecuencias previamente preajustadas en la memoria se borrarán.

Temporizador

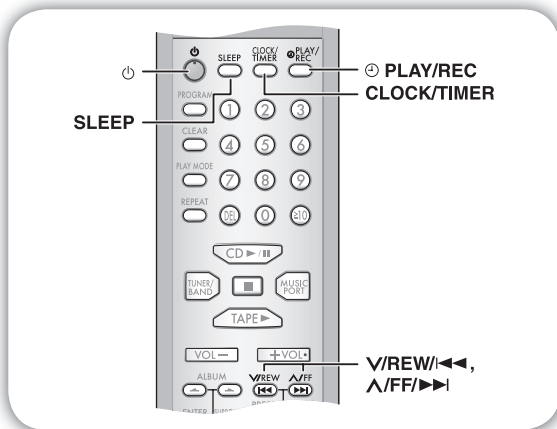

Puesta en hora

Éste es un reloj de sistema de 12 horas.

- 1 Pulse [CLOCK/TIMER] para seleccionar "CLOCK". Cada vez que pulse el botón:

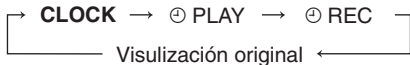

- 2 Entre 5 segundos, pulse [V/REW/◀◀] o [▲/FF/▶▶] para ajustar la hora.



- 3 Pulse [CLOCK/TIMER] para terminar de poner la hora.



Visualización del reloj

Pulse [CLOCK/TIMER] para visualizar el reloj durante unos segundos.

Nota

El reloj puede atrasarse o adelantarse en un plazo de tiempo. Si es necesario vuelva a ponerlo en hora.

Utilización del temporizador de reproducción/grabación

Puede ajustar el temporizador para que se encienda a una hora determinada para despertarle (temporizador de reproducción) o para grabar la radio o fuente de puerto de música (temporizador de grabación).

Preparación

Encienda el aparato y ponga en hora el reloj.

Temporizador	Acción
Temporizador de reproducción	Prepare la fuente musical que desea escuchar: cinta, disco, radio o fuente de puerto de música y ajuste el volumen.
Temporizador de grabación	Compruebe las lengüetas de prevención de borrado del casete (consulte la página 9), inserte el casete y sintonice la emisora de radio (consulte la página 22) o seleccione la fuente de puerto de música (consulte la página 13).

- 1 Pulse [CLOCK/TIMER] repetidamente para seleccionar el temporizador deseado.



- 2 Entre 5 segundos, pulse [◀◀/REW] o [▶▶/FF] para ajustar la hora de inicio.

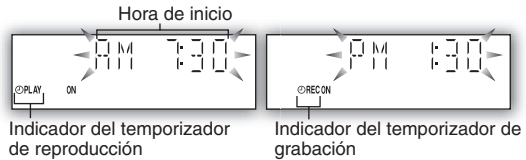

- 3 Pulse [CLOCK/TIMER] para confirmar.

- 4 Repita los pasos 2 y 3 para ajustar la hora de finalización.

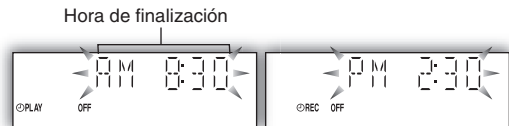

Para activar el temporizador

- 5 Pulse [PLAY/REC] para encender el temporizador deseado.

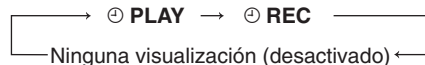

- 6 Pulse [P] para apagar el aparato.

El aparato debe estar apagado para que funcionen los temporizadores.

Otras operaciones básicas

Para	Acción
cambiar la configuración	Repetir los pasos de 1 a 4 y 6.
cambiar la fuente o el volumen	1) Pulse [PLAY/REC] para cancelar el temporizador indicador del visualizador. 2) Cambie la fuente o el volumen. 3) Realice los pasos 5 y 6.
compruebe la configuración (si el aparato está encendido o está en modo de espera)	Pulse [CLOCK/TIMER] repetidamente seleccione [PLAY] o [REC].
cancelar	Pulse [PLAY/REC] para cancelar el temporizador indicadores del visualizador.

Nota

- El temporizador de reproducción no puede utilizarse en combinación con el temporizador de grabación.
- El temporizador de reproducción se pondrá en marcha a la hora programada y el volumen aumentará gradualmente hasta el nivel seleccionado.
- El temporizador de grabación de registro comenzará 30 segundos antes del tiempo del sistema con el volumen silenciado.
- Si el temporizador está activo, se encenderá todos los días a la hora fijada.
- El aparato debe estar en modo de espera para que el temporizador funcione.
- Si apaga el aparato y lo vuelve a encender mientras esté funcionando un temporizador, no se activará el ajuste de tiempo de terminación.
- Si se selecciona el puerto música (MUSIC PORT) como fuente cuando el temporizador avance, el sistema se enciende y se utilice el puerto de música (MUSIC PORT) como fuente. Si desea reproducir o grabar desde el equipo reproductor portátil de audio, sólo ha de activar el modo reproducir del equipo reproductor y aumente el volumen. (Ver el manual de instrucciones del reproductor portátil de audio.)

**Panasonic Consumer Electronics
Company, Division of Panasonic
Corporation of North America**
One Panasonic Way Secaucus,
New Jersey 07094
<http://www.panasonic.com>

Panasonic Puerto Rico, Inc.
Ave. 65 de Infantería, Km. 9.5
San Gabriel Industrial Park, Carolina,
Puerto Rico 00985

Panasonic Canada Inc.
5770 Ambler Drive
Mississauga, Ontario
L4W 2T3
www.panasonic.ca

(En) (Sp)